



风华高科

广东风华高新科技股份有限公司

FENGHUA

GUANGDONG FENGHUA ADVANCED TECHNOLOGY (HOLDING) CO., LTD.

APPROVAL SHEET

CUSTOMER _____

PARTNAME CA45

SPECIFICATION _____

VERSION HUA2002—02

DATE _____

制造			客户		
APPROVAL			APPROVAL		
拟制	审核	确认	检验	审核	批准

No	TABLE OF CONTENTS
1.0	Summary
2.0	Structure And Dimensions
3.0	How To Order
4.0	Performance Specification
5.0	Reliability Data
6.0	Package
7.0	Storage Methods
8.0	Precautions For Use



1.0 Summary

Economy and high performance are combined in the Series CA42 resin-coated, radial –lead,solid electrolyte tantalum capacitor. Solid electrolyte tantalum capacitors have excellent performance. They are small volumes, large capacitance, low leakage current, low dissipation factor and various kind of shape.

- 1.1 Capacitor consist of two conducting surfaces, usually metal plate, whose function is to conduct electricity. An insulating material or dielectric separates them. The dielectric used in all tantalum electrolytic capacitors is tantalum oxide. Tantalum oxide compound possesses high dielectric strength and a high dielectric constant. The film is applied in various thick and at various voltages. Because tantalum oxide have a high dielectric constant, in addition to the fact that extremely thin films can be deposited during the electrolytic process mentioned earlier, makes the tantalum capacitor extremely efficient with respect to the number of microfarads available per unit volume.
- 1.2 The solid tantalum capacitors are polarized devices and may be permanently damaged or destroyed if connected with the wrong polarity. The positive terminal is identified on the capacitor body by a stripe and a beveled edge. The capacitors should not be operated continuously in reverse mode. If two of these polar capacitors are connected “back-to-back”, the pair may be used in AC applications.
- 1.3 Capacitor failure may be induced by exceeding the rated conditions of forward DC voltage, reverse DC voltage, surge current, power dissipation, or temperature.



2.0 Structure And Dimensions

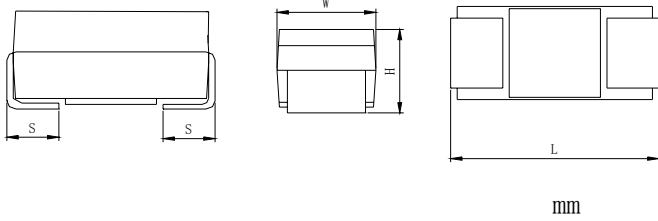

	L±0.3	W±0.3	H±0.3	S±0.3
P	3.2	1.6	1.2	0.8
A	3.2	1.6	1.6	0.8
B	3.5	2.8	1.9	0.8
C	6.0	3.2	2.5	1.3
D	7.3	4.3	2.8	1.3

Rated Voltage (V)	4	6.3	10	16	20	25	35	50
	0G	0J	1A	1C	1D	1E	1V	1H
85°C Surge Voltage (V)	5.2	8	13	20	26	32	46	65
125°C Derated Voltage (V)	2.5	4	6.3	10	13	16	22	32
Cap(μF)	(Case code)							
Code								
0.1	104						A	A
0.15	154						A	B
0.22	224						A	B
0.33	334					A	A	B
0.47	474				A	A	A.B	C
0.68	684			A	A	A.B	A.B	C
1.0	105		A	A	A.B	A.B	A.B	C
1.5	155	A	A	A	A.B	A.B	B.C	D
2.2	225	A	A	A.B	A.B	A.B	B.C	D
3.3	335	A	A.B	B	A.B	A.B.C	B.C	D
4.7	475	A.B	A.B	A.B	A.B.C	B.C	B.C	D
6.8	685	A.B	A.B	A.B.C	B.C	B.C	C.D	D
10	106	A.B	A.B.C	A.B.C	B.C	B.C.D	C.D	D
15	156	A.B.C	B.C	B.C	B.C.D	C.D	C.D	D
22	226	A.B.C	A.B.C.D	A.B.C.D	B.C.D	C.D	D	D
33	336	B.C	A.B.C.D	B.C.D	C.D	D	D	
47	476	B.C.D	A.B.C.D	B.C.D	C.D	D	D	E
68	686	C.D	B.C.D	C.D	D			
100	107	C.D	B.C.D	C.D	D			
220	227	C.D	C.D	D	E			
470	477			E				



3.0 How To Order

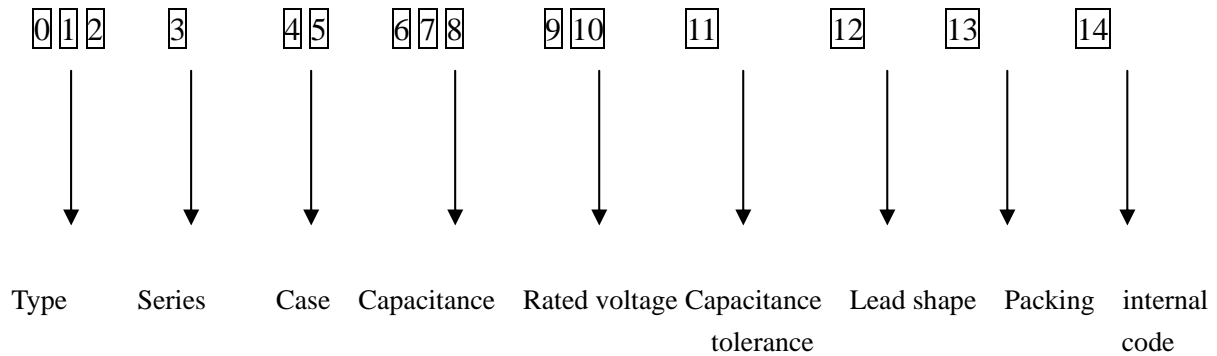

3.1 012 : Type

T 4 2 : High performance to standard for general

T 4 5 : Molded chip solid tantalum electrolytic capacitor

3.2 3 : Series code

Code	Series
0	general purposes
1	low impedance

3.3 45 : Shape and dimensions

Code	Size (max)	Code	Size (max)
A1	3.2×1.6×1.6	D1	7.3×4.3×2.8
B1	3.5×2.8×1.9	E1	7.3×4.3×4.0
C1	6.0×3.2×2.5		



3.4 **678** : (C) Rated capacitance

Rated capacitance (μ F)	Code	Rated capacitance (μ F)	Code
0.1	104	4.7	475
0.15	154	6.8	685
0.22	224	10	106
0.33	334	15	156
0.47	474	22	226
0.68	684	33	336
1	105	47	476
1.5	155	68	686
2.2	225	100	107
3.3	335	220	227

3.5 **910** Rated working voltage (WV)

Voltage	Code	Voltage	Code
4	0G	25	1E
6.3	0J	35	1V
10	1A	50	1H
16	1C		

3.6 **11** Capacitance tolerance

Code	Tolerance	Code	Tolerance
J	$\pm 5\%$	Q	-10~+30%
K	$\pm 10\%$	T	-10~+50%
M	$\pm 20\%$	Z	-20~+80%
V	-10~+20%	A	Special

3.7 **12** : A Identification of lead configurations

3.8 **13** : Packing

Code	
B	Bulk
P	Taping



3.9 14 : Internal code

 1 : Standard

 2 : Special grade

4.0 Performance Specification

Item	Performance Characteristics	
Operating Temperature Range	-55~+125°C(applied rating voltage at greater than 85°C)	
Capacitance tolerance	± 10 % (K) , ± 20 % (M) at 120Hz +25°C	
Rated voltage	4V~50V	
125°C Derated voltage(V)	To table 1	
Leakage current (25°C)	<ul style="list-style-type: none"> ◦ • After 1minute's application of rated voltage, leakage current at 25 °C is not more than 0.01C_RU_R μ A or 0.5 μ A.,whichever is greater. 	
Dissipation Factor (tg δ)	120Hz Test frequency 120Hz 0.1~1 μ F 4% Max 、 1.5~68 μ F 6% Max 100 uF~150 μ F 8% Max 、 220 μ F ~ 10 % Max	
In special (tg δ)	120Hz Test frequency 120Hz 16V 10 μ F A 8%、 4V 68 μ F B 8%、 6.3V 68 μ F B 8%、 16V 22 μ F B 8%、 16V 47 μ F C 8%	
85°C Surge voltage(V)	After application of surge voltage (table 1) in series with a 33 Ω resister in 30 seconds ON, 30 seconds OFF, for 1000 successive test cycles at 85°C, capacitors meet the characteristics requirements listed below.	
	Capacitance Change	Within ± 5% of initial value
	Dissipation Factor	Initial specified value or less
	Leakage Current	Initial specified value or less



5.0 Reliability Data

Item	Performance Characteristics	
Resistance to Soldering Heat	After immersing the capacitors completely for 5 ± 0.5 sec at $260 \pm 5^\circ\text{C}$, capacitors meet the characteristic requirements listed below.	
	Capacitance Change	Within $\pm 3\%$ of initial value
	Dissipation Factor	Initial specified value or less
	Leakage Current	Initial specified value or less
Solder ability	Dipping 3/4 of the termination into the solder ($230 \pm 5^\circ\text{C}$) for 3 ± 0.5 sec to get a fresh and smooth surface.	
Humidity Resistance	At 40°C , 90~95%R.H., For 500hours (No voltage applied).	
	Capacitance Change	Within $\pm 12\%$ of initial value
	Dissipation Factor	Initial specified value or less
	Leakage Current	Initial specified value or less
Load Life	After 2000 hour's application of rated voltage in series with a $3\ \Omega$ resistor at $+85^\circ\text{C}$ or rated voltage in series with a $3\ \Omega$ resistor at 125°C , capacitance meet the characteristics requirements listed below.	
	Capacitance Change	Within $\pm 10\%$ of initial value
	Dissipation Factor	Initial specified value or less
	Leakage Current	Initial specified value or less



Item	Performance Characteristics
Shear test	<p>After applying the pressure load of 5N for 10 ± 1 seconds horizontally to the center of capacitor side body which has no electrode and has been soldered beforehand on an aluminum substrate. Neither exfoliation nor its sign shall be found at the terminal electrode.</p>
Terminal strength	<p>Keeping a capacitor surface-mounted on a substrate upside down and supporting the substrate at both of the opposite bottom points 45mm apart from the center of the capacitor, the pressure load is applied with a specified at the center of the substrate so the substrate may bend by 1mm . Then, there shall be found no remarkable abnormality on the capacitor terminals.</p>

1 Table 1

Rated voltage (V)	85°C Surge voltage (V)	125°C Rated voltage (V)
4	5.2	2.5
6.3	8	4
10	13	6.3
16	20	10
20	26	13
25	32	16
35	46	22
50	65	32



6.0 Packing

6.1 Structure of leader part and part of the carrier taping

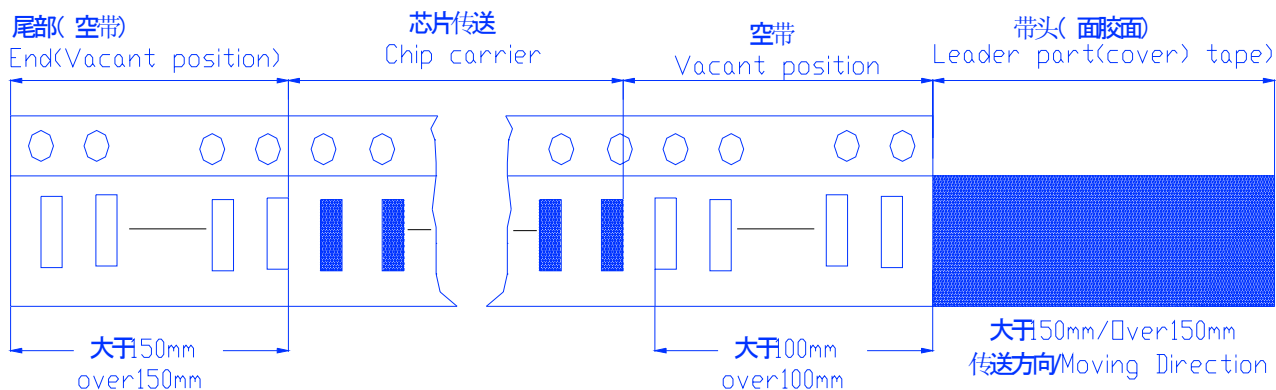

6.2 Reel Dimensions (unit:mm)

卷盘尺寸 TAPE REEL DIMENSIONS

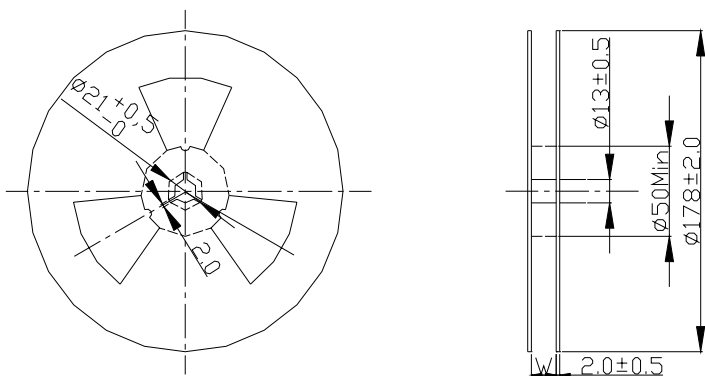

Unit:mm

	P	A	B	C	D
$W \pm 0.3$	10	10	10	14	14



6.3 Cover tape

Standard: $0.1N < \text{peeling strength} < 0.7N$

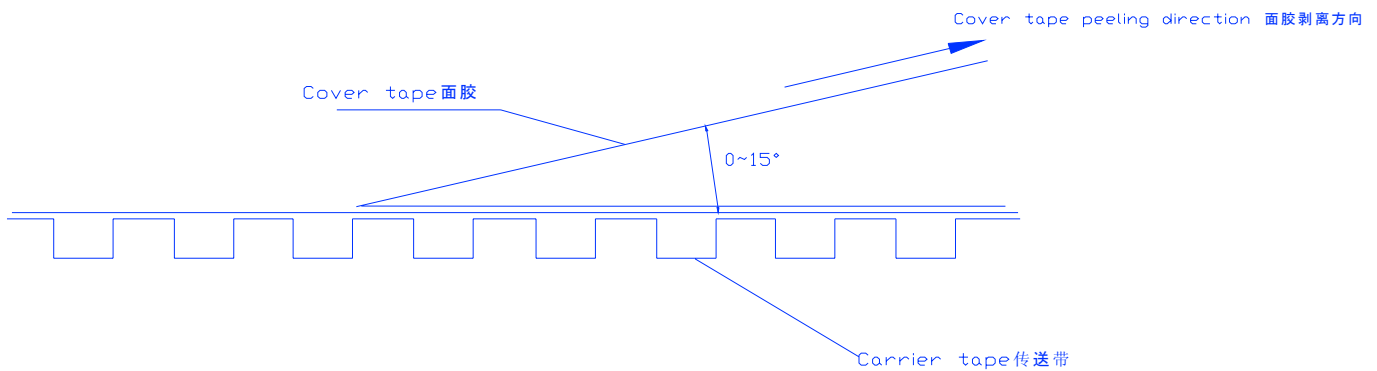

7.0 Storage Methods

Store the capacitors in the package not to be exposed to direct sunlight and dust. Store in the environment holding ordinary temperature ($5 \sim 35^\circ\text{C}$) and ordinary humidity (75% RH or less). Storing period is 2years and 6months after manufacturing in principle. As for products stored for more than the storing period, perform re-examination and confirm no abnormality of the products before use.

8.0 Precautions For Use

8.1 Using Voltage

To improve the product reliability, control the surge voltage under 50% of the rated voltage of parts, Especially if using for low impedance circuit, control the surge voltage under 30% of the rated voltage.(Refer to Figure 1, 2, 3)



If applying for series protection resistance in the charge/discharge circuit with high momentary current, control the current which is applied to the capacitor under 300mA and control the surged voltage under 30% of the rated voltage.

8.2 If using over 85°C apply the derated voltage under 50% or 30% of the Figure 3.

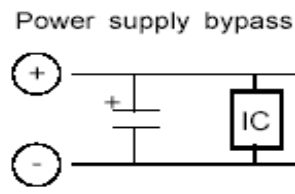
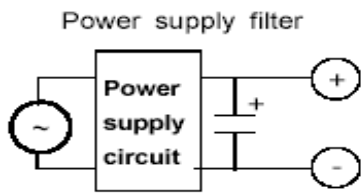

Fig. 1

Fig. 2

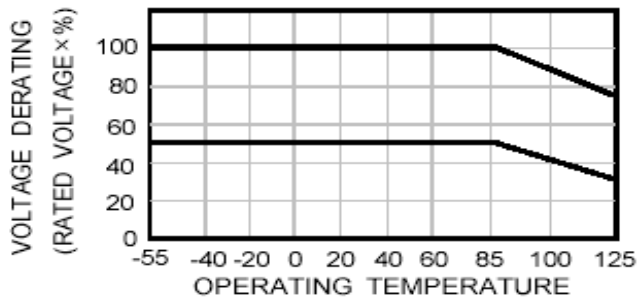

Fig. 3

1: Table:1

Circuit Impedance Reliability Factor

Circuit Impedance (Ω/V)	Failure Rate Impedance
0.1	1.0
0.2	0.8
0.4	0.6
0.6	0.4
0.8	0.3
1.0	0.2
2.0	0.1
3.0 or greater	0.07

8.3 Solid tantalum capacitors are polar capacitor. Reverse voltage is not permissible.



8.4

The temperature profile in the adjacent graph

(Re-flow soldering)

(Wave soldering)

Temperature
°C

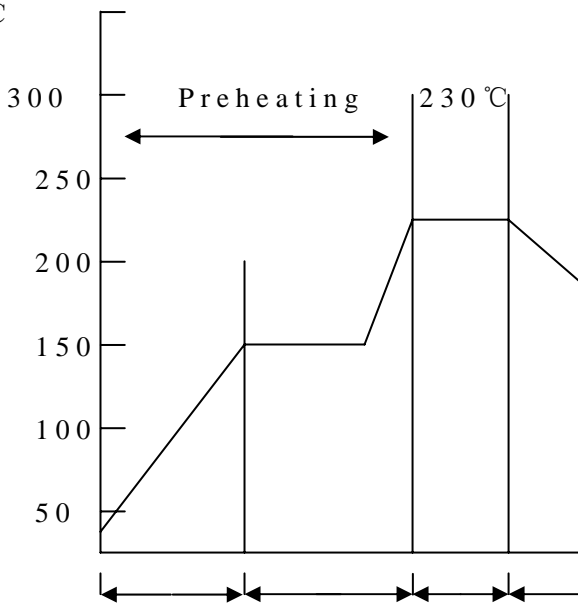

Over 1 minute Over 1 minute 5S Gradual Cooling

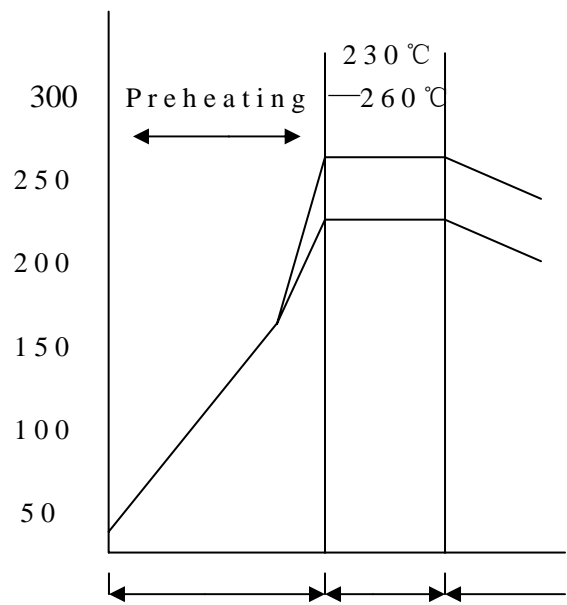

Over 2 minute 3S max Gradual cooling

8.5 Solder ability

The capacitors are designed as to the failure per 1000hrs in applying rated voltage at 85°C. (1% per 1000hrs)

The steady state reliability of Tantalum capacitor is determinate by various factors. (eg. Operation temperature, Working voltage, Series resistance of the external circuit, etc.) .Therefore if the factors have a additional margins at circuit the steady state performance of the capacitor for long time could be derived.

The failure rate of capacitor can be calculated as follows.

The formula of failure rate

$$\lambda_{use} = \lambda_{85} \times K_V \times K_t \times K_R$$

λ_{use} : the estimated failure rate of the capacitor under operating condition λ_{85} : basic failure rate

K_V : working voltage K_t : operating temperature K_R : charging current



图5 Fig5

8.5 CA45 Lard Size



	Flow Soldering			Reflow Soldering		
	a	b	c	a	b	c
A	1.6	2.6	1.3	1.6	1.5	1.3
B	2.6	2.8	1.5	2.6	1.6	1.5
C	2.8	3.8	2.8	2.8	2.2	2.8
D	3.8	4.5	4.0	2.8	2.4	4.0

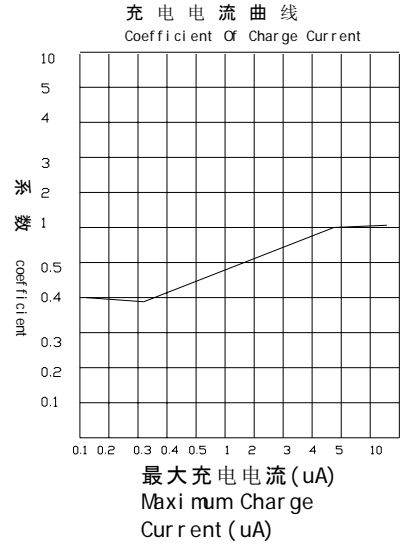
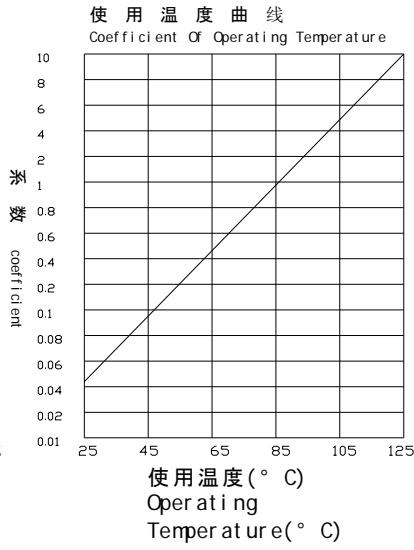
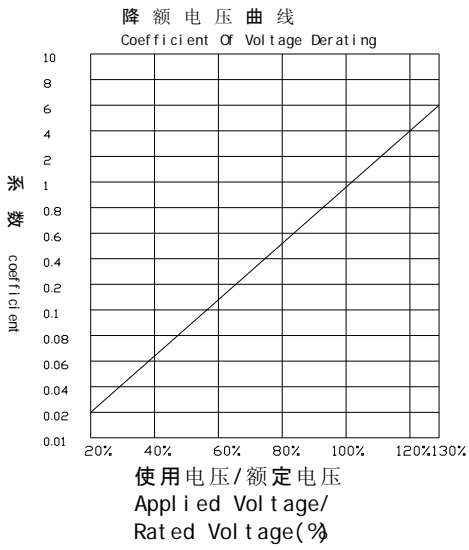
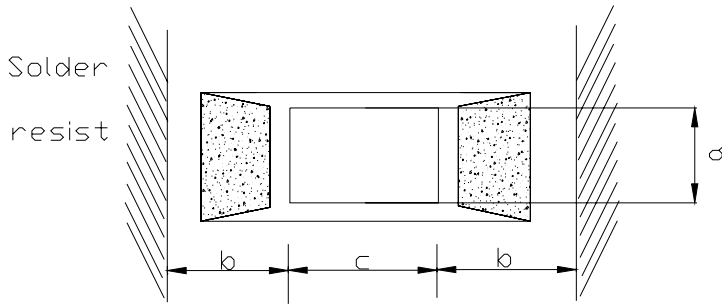